

Features of the Range:

Polar Refrigeration's Heavy Duty commercial range has been created with the busy commercial kitchen in mind.

These tough, robust cabinets are designed to work effectively in high ambient temperatures and have features such as forced air cooling, heated defrost, stainless steel interior, high quality LED display's and lockable castors.

Polar Heavy Duty Range is the ideal choice for the commercial food-service professional. Our Polar Heavy Duty cabinets provide even temperatures and fast recovery times.



Features and Benefits:

- Automatic defrost regularly defrosts the evaporator in a refrigerator or freezer saving time in a kitchen
- Forced air cooling recovers the unit's temperature faster
- Rear Upstand available to prevent items falling down the back of unit
- Lockable castors make the unit easy to move and secure into place

DL917

Dimensions:

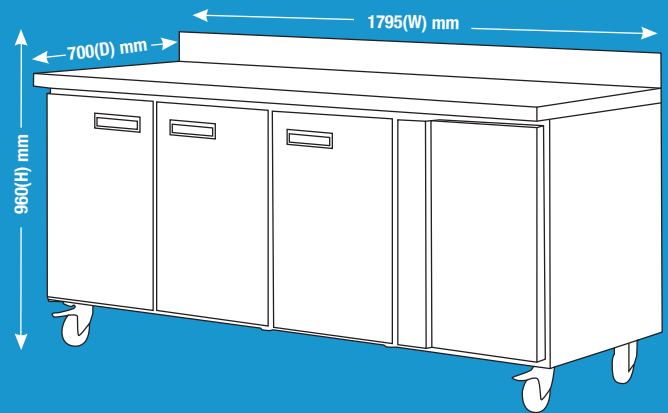



Optional Extras

Additional shelves	Yes
Additional runners	Yes
Seal Replacements Available	Yes
Other Finishes Available	None

Specification:

Code	DL917	Voltage/Power	230V/50HZ
Fridge Type	Counter Freezer	Cooling System	Forced Air
Capacity	358 Ltr	Insulation Thickness	60mm
Gastronorm Compatible	Yes	Weight	143KG
Number of Shelves	3	Rollers, Feet or Castors	Castors
Door Type	Solid	Control Panel	Digital
Internal Material	Stainless Steel	Noise Level	-
External Material	Stainless Steel	Lockable	Yes
Temperature Range	-22°C to -18°C	Hinge Side	N/A
Ambient Temperature Range	5°C to 32°C	Depth with Door Open	1070mm
Refrigerant	R404a	Energy Consumption (KWH/Year)	3197
Defrost System	Heated		

Supplier - Aanbieder - Fournisseur - Distribuidor - Anbieter	
Model - Modelnummer – Numéro du modèle – Modelo número - Modellnummer	DL917
Category - Type apparaat – Type de modèle – Modelo tipo - Modellkennzeichen	Counter Cabinet (Freezer)
Energy Efficiency Class – Energieklasse - Classe énergétique - Eficiencia energetic - Eficiência energetic – Energieeffizienzklasse	D
EEl	72
E24h (KWh)	9
Annual energy Consumption (KWh/year) - Energieverbruik per jaar (kWh/jaar) – Consommation énergétique annuelle (kWh/an) - Consumo energético annual (kWh/año) - Consumo energético anual (kWh/año) - Jährlicher Energieverbrauch (kWh/Jahr)	3197
Net Volume Fridge (Litres) - Netto volume koeling (liters) - Volume net unité positive (Litres) - Volumen neto del frigorífico (litros) - Capacidade líquida do Frigorífico (Litros) - Nettoinhalt Kühlgeräte (Liter)	N/A
Net Volume Freezer (Litres) - Netto volume vriezer (liters) - Volume net unité négative (Litres) - Volumen neto del congelador (litros) - Capacidade líquida do Congelador (Litros) - Nettoinhalt Gefriergeräte (Liter)	358
Climate Class - Klimaatklasse - Classe climatique - Clasificación climatic - Classificação climatic – Klimaklasse	4



ENERG Y IJA
enerгия · ενεργεια
IE IA



DL917



ENERGIA · ЕНЕРГИЯ · ΕΝΕΡΓΕΙΑ
ENERGIJA · ENERGY · ENERGIE
ENERGI

3197
kWh/annum



0 L



358 L



4
30°C-55%

2015/1094-I